

TP-118 Power Tube

Application Note

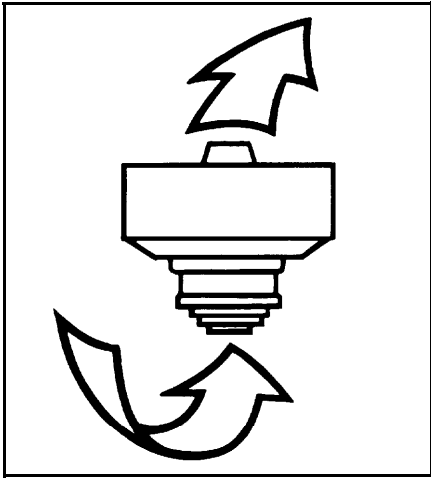

Application Guide for Forced-Air Cooling of BURLE Power Tubes

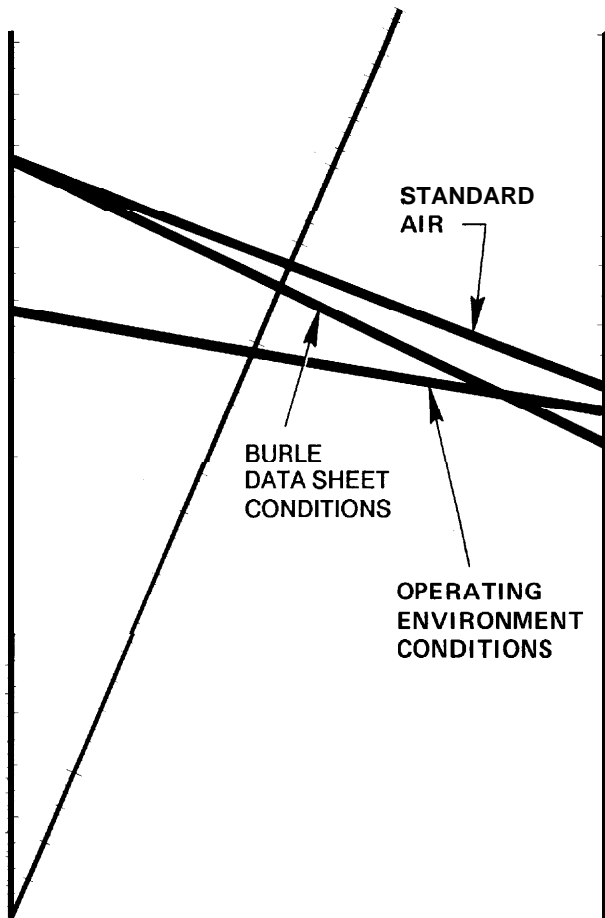

Cooling Characteristics

Foreword

BURLE INDUSTRIES, INC., has prepared this booklet to emphasize those considerations important for effective forced-air-cooling of BURLE power tubes. It will help the equipment and system designer in the selection and installation of cooling components and systems.

Close attention to the information contained herein will improve tube life and reduce equipment downtime.

For more detailed information or guidance with a particular problem, contact your BURLE Field Representative or write Power Tube Application Engineering, BURLE INDUSTRIES, INC., 1000 New Holland Ave., Lancaster, PA 17601-5688; (717) 295-6888.

Section I

Introduction

The design of BURLE power tubes has been an evolutionary process. Power and dissipation ratings and maximum frequencies have increased. The compact, high-frequency tube designs require special consideration in the development of air cooling systems to obtain the desired performance and maintain efficient power generation.

To assist the user in more fully understanding the problems of air cooling, the specifications of tubes and typical systems will be reviewed. The differences between laboratory or shop cooling systems and those used in operating environments will be compared. The methods of measurements will be described and an example of a cooling system design will be developed to show a method for choosing the proper blower and specifying the required blower pressure and volumetric flow.

Section II

Thermal Specifications

BURLE power tubes are evaluated for cooling requirements during design to assure adequate temperature control. Construction methods and expected life dictate maximum temperature limits for critical locations such as the ceramic-metal seals and the anode. Measurements then determine the volume of air required to hold the temperature excursions within these limiting values for specific levels of power output.

A typical "Cooling Characteristic Curve" for the BURLE Beam Power Tube, Type 8794 is shown in **Figure 1**. This drawing shows four curves for different levels of anode dissipation. In **Figure 1**, each curve includes a factor for typical filament, screen, and grid power at the indicated anode dissipation levels. Thus, the user need concern himself only with the anode dissipation for his anticipated operation. However, specific instructions for directing the cooling air at other terminals are separate from the anode.

Charts for tubes of other manufacture may specify total heat to be removed. Thus the filament and grid power must be added to the anode dissipation and this total used to determine cooling requirements. It is important to know and use the tube cooling specifications in their intended manner.

In addition, the "pressure drop" shown is the pressure drop measured across the tube alone. Additional pressure must be supplied to compensate for losses in the cooling ducts, chimneys, socketry, filters and any other components of the total system.

The pressure drop in the ducts that lead from the blower to the tube and from the tube to the ambient environment are all factors in the total system drop and must be considered when determining cooling requirements. It is not uncommon for the system drop in a typical 200 cfm system to include 0.2 inch H₂O for the socket and duct leading to the base of the tube, 0.1 inch H₂O for the air filter and RF shielding and an additional 0.1 inch H₂O for the exhaust duct and the cabinet back pressure. For a typical tube requiring 2.0 inches H₂O of static pressure at 200 cfm, system losses can amount to 0.4 inch H₂O additional. The blower would then be required to move 200 cfm against 2.4 inches H₂O. A good rule of thumb for an unknown system drop in an efficient system is 20 percent of the tube drop.

While the values discussed above are practically impossible to calculate, they can be estimated fairly closely, and when the equipment is built, they can readily be measured with very simple instruments. These techniques will be covered in a later section on measurements.

The values of air flow from **Figure 1** dictate the cfm necessary to limit the temperature to maximum values based on the suppo-

sition that the user will provide compensation for all probable system variables to insure against exceeding the limiting values. The system engineer should design the equipment so that initially and throughout life, the maximum temperature is never exceeded under the worst probable operating conditions with respect to operating variations: supply voltage fluctuations, environmental changes, maintenance period extensions, and variations in device characteristics. In addition, operation of the tube at temperatures below the limiting values will measurably increase the life expectancy of the tube. Therefore, the cooling system should be designed to limit the maximum temperature of the tube to a value 25° to 50° below the specified maximum. This safety factor can mean a considerable increase in life expectancy.

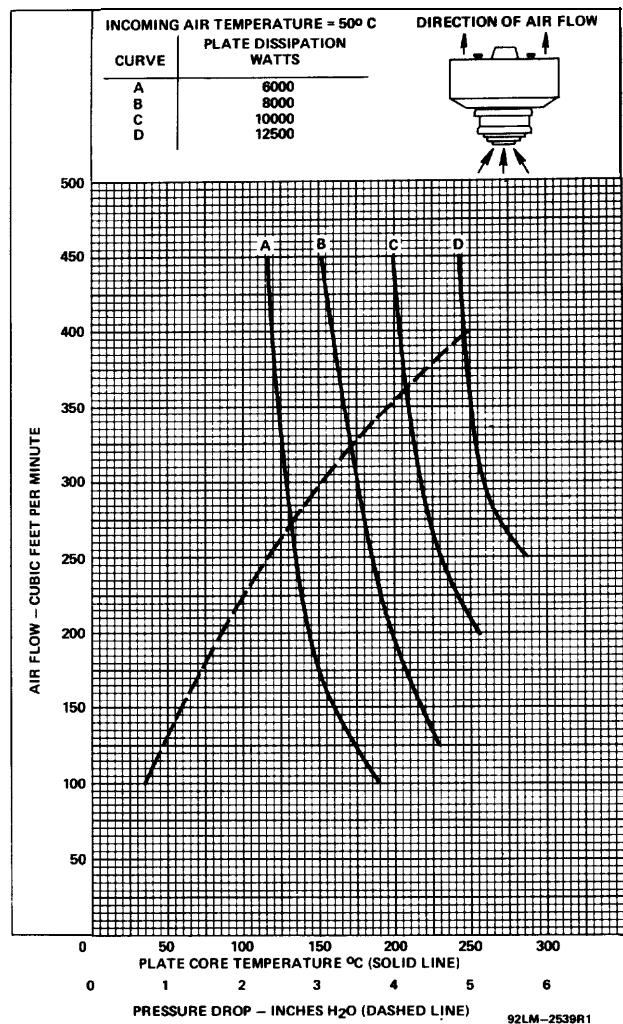

Figure 1 - Cooling Characteristics - BURLE Tube Type 8794

Section III

Design for Environment

The cooling capacity of air is a function of its mass, not its volume. As the altitude is increased, the air density and its cooling capacity are reduced. Therefore, if a tube is to be operated at a substantial altitude, a correction factor proportional to the altitude will need to be applied to the volumetric flow to assure the greater volume required for cooling with lower density air.

This correction factor for altitude (F_A), when applied to sea level values for air requirements, determines the amount of air needed for equal cooling at the operating altitude.

The correction factor is equal to the ratio of the barometric pressure at sea level divided by the barometric pressure at the altitude of operation.

$$F_A = \frac{P_{A1}}{P_{A2}}$$

where P_{A1} is the barometric pressure at laboratory conditions for sea level (29.92 inches Hg) and P_{A2} is the barometric pressure at the operating altitude.

Thus with laboratory conditions specified at sea level, the altitude correction factor F_A has been determined as follows:

Operating Altitude (A)	Correction Factor (F_A)
Sea Level	1.00
5,000 ft.	1.20
10,000 ft.	1.46
15,000 ft.	1.77
20,000 ft.	2.17

Figure 2 is a visual presentation of these data.

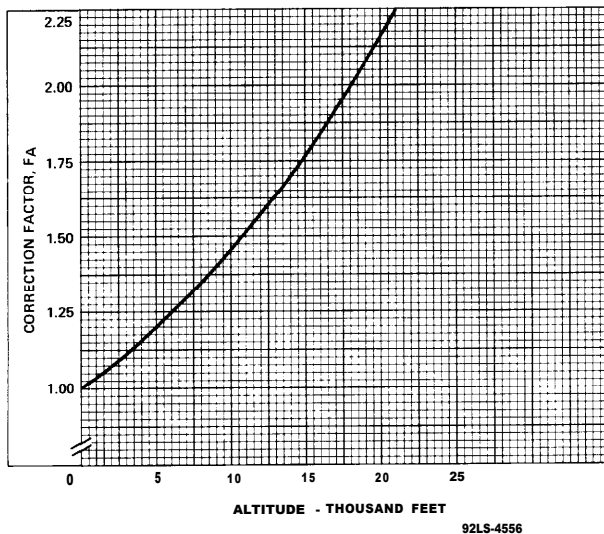

Figure 2 - Correction Factor for Altitude, F_A

In addition, the density of the air and thus its cooling capacity is inversely proportional to the absolute temperature of the air. As the temperature rises, the mass, and hence the cooling capacity, is reduced, and more cfm of air is needed for equal cooling. **Therefore, a correction factor for temperature, F_T , must be applied to the volumetric air flow to assure the greater volume of air required for cooling at lower density.**

The correction factor for temperature (F_T) is directly proportional to the ratio of the absolute temperature of the operating environment (T_2) to the absolute temperature of the tube specification conditions (T_1). In the International System of Measurements (ISM) this ratio is as follows:

$$F_T = \frac{273 + T_2}{273 + T_1}$$

The following table lists the correction factors applicable for specific differences between operating conditions and the temperature at which the specifications were developed.

Table I

Correction Factor for Temperature

ΔT	F_T
+ 30°	1.10
+ 20°	1.07
+ 10°	1.03
0°	1.00
- 10°	0.97
- 20°	0.93
- 30°	0.90

ΔT is the difference between the inlet air temperature in the specification (T_1) and the inlet air temperature in the operating environment (T_2).

$$\Delta T = T_2 - T_1$$

The nomograph shown in **Figure 3** gives the air density for all pertinent values of temperature and altitude. The ratio of the air density at specification conditions to the air density at operating conditions constitutes a combination correction factor (F_{AT}) compensating for both temperature and altitude. To determine the volume of air required at operating conditions, multiply values for air flow and pressure drop obtained for specification conditions by F_{AT} .

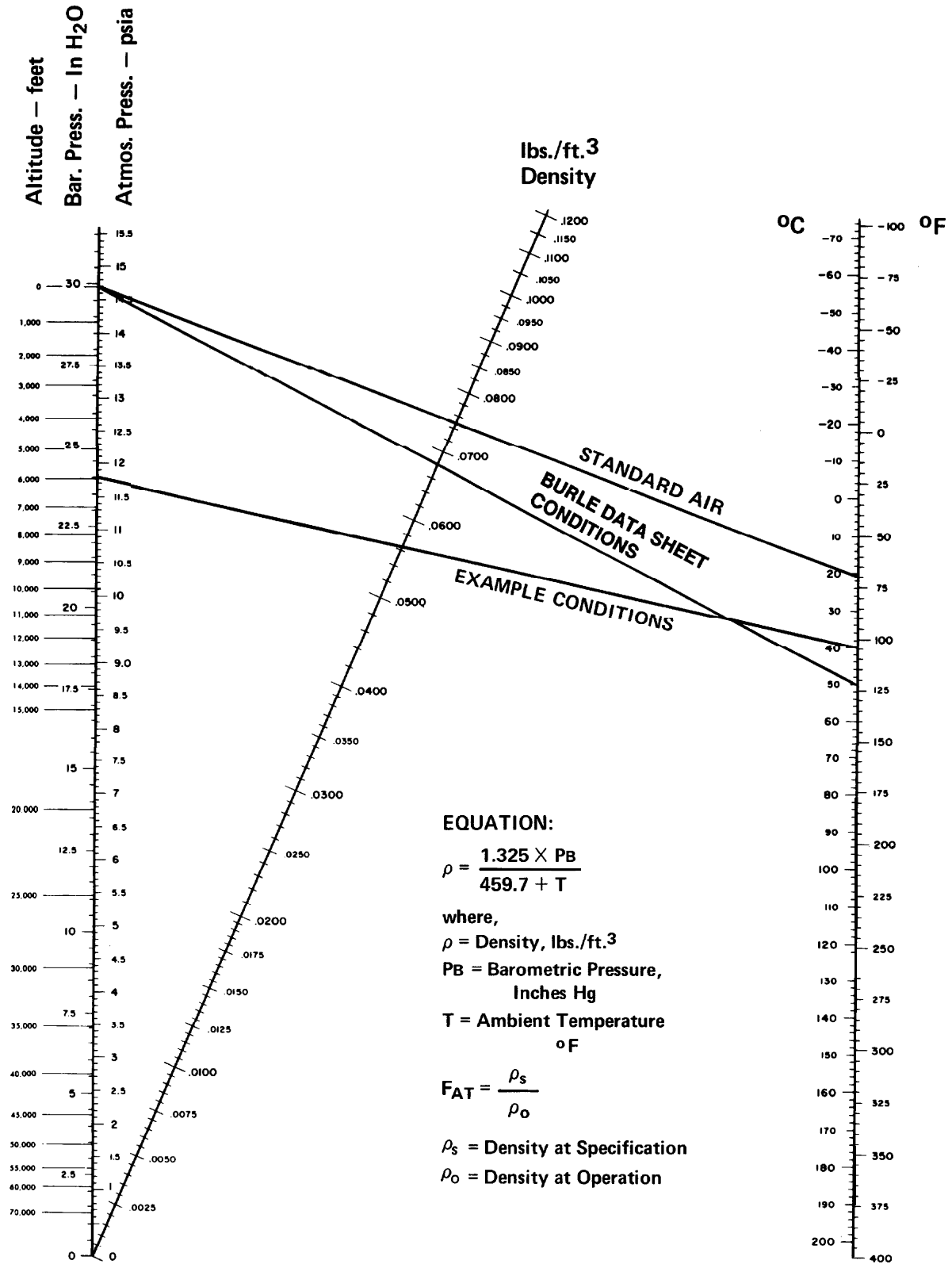

Copyright 1955 by ROTRON, INC.
 Reproduction only by written permission.

Figure 3 - Nomograph for Altitude-Temperature Correction Factors (Reprinted with permission of Rotron, Inc.)

Section IV

Blower Characteristics

The selection of the most efficient fan or blower depends on many factors which include: limitations on size and weight, power supply availability, noise level, mounting requirements, cost, in addition to the ability to move a required amount of air against a specified pressure. In this paper, the requirements for air flow and pressure will be paramount.

The manufacturers of fans and blowers specify their product at laboratory conditions of temperature and sea level atmospheric pressure. They publish curves showing performance (air flow and static pressure). Two examples are described by typical curves shown in **Figure 4**. **Figure 4a** depicts one blower with a uniform curve that reduces pressure gradually for an increase in air flow over the normal operating range. The other blower presents a curve like that in **4b** which shows a varying change in pressure for a large change in flow.

All fans, whether they be axial, centrifugal or mixed flow, belong to the category of dynamic energy devices and as such follow the "Fan Laws". One of these laws, simply stated, says that a fan will operate at its maximum flow rate controlled by the back pressure developed, and also that the pressure developed is directly proportional to the density of the air being moved.

Thus the fan must meet the requirements for air flow and pressure as dictated by the operating environment. The altitude-temperature correction factor must also be applied to the fan specification to assure effective performance at operating air density.

Blowers are also specified for use at various line frequencies (50, 60, 400 Hz). There is a large variation in performance from one frequency to the next and care must be employed that the blower specifications match those of the operating conditions (power supply).

In general, static pressure capability will be 25% to 50% less for a blower operated at 50 Hz than when operated at 60 Hz. A 60 Hz blower should not be used with 400 Hz power.

When using a three-phase electrical system, always use three-phase motor starters rather than fuses. Once a motor is started and a single fuse blows, the motor will continue to run single phase at reduced speed. This condition can result in tube failure or motor burn out. Air flow switches and interlocks are recommended to remove all primary power from the tube if the air system fails or the flow is reduced.

This advice is important in that it can be the difference between satisfactory performance and total failure.

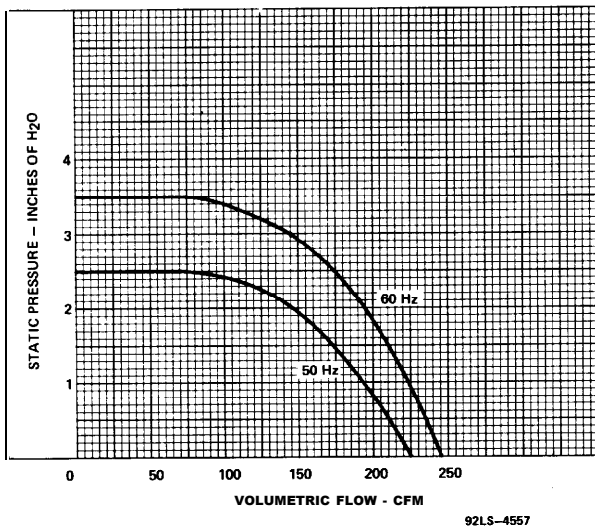

4a - Rotron KS-601

Figure 4 - Static Pressure vs Volume of Air Flow

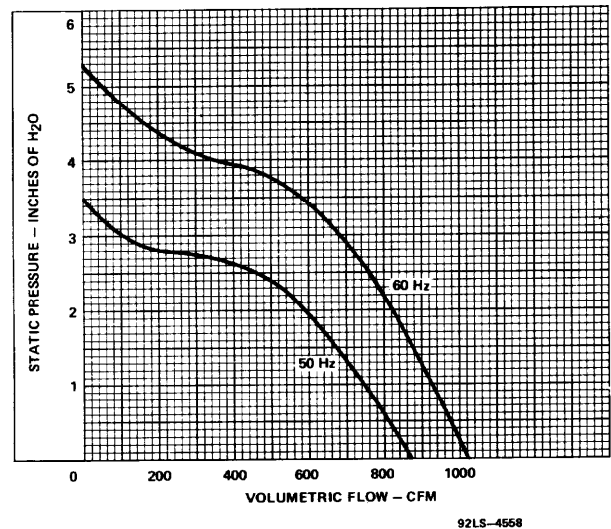

4b - Rotron AS-704

Section V

Sample Calculations

Now that the various characteristics of air and specifications for tubes and blowers have been reviewed individually, they will be related one to the other by means of a sample problem.

It is desired to construct a video transmitter installation using a BURLE 8794 Tube Type, operating at an output power of 9800 watts, black level. The site selected is at an altitude of 6000 ft. above sea level and the cooling air will be at a temperature of 40 °C maximum when it reaches the tube.

To accommodate system variations, and to extend life, a safety factor of 50 °C with respect to the specified limit for maximum operating anode core temperature will be used. It is also estimated that, because the cooling system will be simple and efficient, a factor of 20% of the tube pressure drop will cover the pressure losses in the balance of the system.

In a poorly designed or complex system having bends, filters, discontinuities, obstructions, etc., this factor could be much higher, even up to 100%. A common error is the installation of screens for rf shielding at the base of the tube socket or in the duct leading to or from the tube. A second area is the selection of air filters that restrict the air flow and starve the blower. Oversize filters are required to allow for dirt accumulation between maintenance activities. Question: What air flow and pressure drop are required? Solution: The solution will follow a prescribed formula filling blocks in the "Cooling Requirements Table".

The blank "Cooling Requirements Table" is provided for your use. Instructions for calculating the answer for each block are on page 9. When completed, but before applying power to the tube, you may have these numbers reviewed by sending the completed table or a copy to BURLE Power Tube Application Engineering.

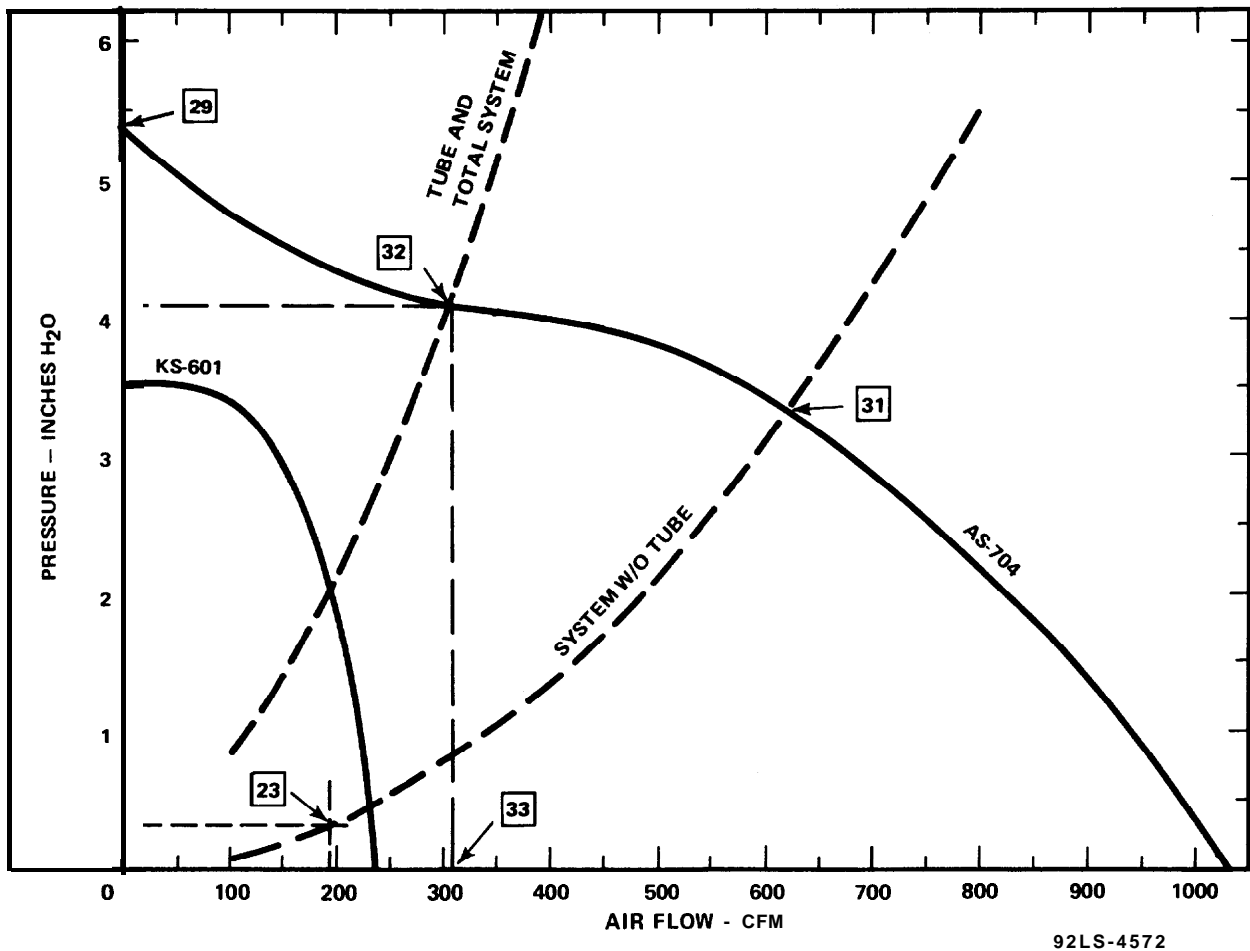

Figure 5 - Air Flow - Pressure Characteristics (Standard Air)

Cooling Requirements -Table II

Parameter	Tube Spec.	Operating Environment	Blower Spec.	System Check-Out User's Lab
Power to be Dissipated	___ W ¹	___ W ²		___ W ³
Safety Factor		___ °C ⁴		
Maximum Mean Core Temperature	___ °C ⁵	___ °C ⁶		
Incoming Air Temperature	___ °C ⁷	___ °C ⁸	___ °C ⁹	___ °C ¹⁰
Altitude	___ ft ⁷	___ ft ⁸	___ ft ⁹	___ ft ¹⁰
Correction Factor for Altitude (F _A)		___ ¹¹	___ ¹²	
Correction Factor for Temperature (F _T)		___ ¹³	___ ¹⁴	
Combined Correction Factor (F _{AT})		___ ¹⁵	___ ¹⁶	
Minimum Air Flow	___ cfm ¹⁷	___ cfm ¹⁸	___ cfm ¹⁹	___ cfm ²⁰
Pressure Drop (Tube Only)	___ " H ₂ O ²¹	___ " H ₂ O ²²		
Pressure (System w/o Tube)	___ " H ₂ O ²³	___ " H ₂ O ²⁴		
Pressure (System + Tube)	___ " H ₂ O ²⁵	___ " H ₂ O ²⁶	___ " H ₂ O ²⁷	
Blower Selected			___ ²⁸	
To check-out the entire system before installation at the final location, set up in the user's laboratory.				
Zero Flow Pressure			___ " H ₂ O ²⁹	___ " H ₂ O ³⁰
Typical-Flow Pressure (System w/o Tube)				___ " H ₂ O ³¹
Typical-Flow Pressure (System + Tube)				___ " H ₂ O ³²
Typical Air Flow (System + Tube)				___ cfm ³³
Equivalent Flow at Tube Spec. Conditions				___ cfm ³⁴
Expected Mean Core Temperature				___ °C ³⁵
Maximum Mean Core Temperature				___ °C ³⁶
Actual Mean Core Temperature				___ °C ³⁷

Cooling Requirements - Table III

Parameter	Tube Spec.	Operating Environment	Blower Spec.	System Check-Out User's Lab
Power to be Dissipated	8000W ¹	8000W ²		8000 W ³
Safety Factor		50°C ⁴		
Maximum Mean Core Temperature	250°C ⁵	200 °C ⁶		
Incoming Air Temperature	50°C ⁷	40°C ⁸	20°C ⁹	20°C ¹⁰
Altitude	Zero ft ⁷	6000ft ⁸	Zero ft ⁹	Zero ft ¹⁰
Correction Factor for Altitude (F _A)		1.25 ¹¹	1.25 ¹²	
Correction Factor for Temperature (F _t)		0.97 ¹³	1.07 ¹⁴	
Combined Correction Factor (F _{AT})		1.21 ¹⁵	1.34 ¹⁶	
Minimum Air Flow	195 cfm ¹⁷	237 cfm ¹⁸	237 cfm ¹⁹	237 cfm ²⁰
Pressure Drop (Tube Only)	1.60" H ₂ O ²¹	1.94" H ₂ O ²²		
Pressure (System w/o Tube)	0.32" H ₂ O ²³	0.39" H ₂ O ²⁴		
Pressure (System + Tube)	1.92" H ₂ O ²⁵	2.33" H ₂ O ²⁶	3.14" H ₂ O ²⁷	
Blower Selected			AS-704 ²⁸	
To check-out the entire system before installation at the final location, set up in the user's laboratory.*				
Zero Flow Pressure			5.3" H ₂ O ²⁹	5.3" H ₂ O ³⁰
Typical-Flow Pressure (System w/o Tube)				3.2" H ₂ O ³¹
Typical-Flow Pressure (System + Tube)				4.1" H ₂ O ³²
Typical Air Flow (System t Tube)				310 cfm ³³
Equivalent Flow at Tube Spec. Conditions				341 cfm ³⁴
Expected Mean Core Temperature				170°C ³⁵
Maximum Mean Core Temperature				178°C ³⁶
Actual Mean Core Temperature				170°C ³⁷

Conditions, for this example, are assumed to be 20° C and at sea level.

1. Determined from expected operating conditions. This example of a typical TV transmitter operating at 9800 watts black level with 55% efficiency has an anode dissipation of 8000 watts.
2. Same as Item 1.
3. Same as Item 1.
4. Selected to accommodate all probable system variations and to extend life.
5. From Tube Specification.
6. Item 5 less Item 4.
7. From Tube Specification Cooling Characteristics.
6. From expected operating conditions.
9. From blower specification.
10. From expected User-Laboratory conditions.
11. Tube specification to operating environment, see Figure 2. (This example: F_A for 6000 ft)
12. Blower specification to operating environment, see Figure 2. (This example: F_A for 6000 ft)
13. Operating environment less tube specification, see Table I. (This example: FT for $\Delta T = 40^\circ - 50^\circ = -10^\circ$)
14. Operating environment less blower specification, see Table I. (This example: FT for $\Delta T = 40^\circ - 20^\circ = +20^\circ$)
15. Item 11 times Item 13.
16. Item 12 times Item 14.
17. From Cooling Characteristic in the tube specification, at the selected operating conditions, core temperature in Item 6 and power in Item 2.
18. Item 17 times Item 15.
19. Same as Item 18. Because the blower is a constant volume device, the specification for air flow is the same for sea level or altitude operation.
20. Same as Item 19.
21. From Cooling Characteristic Curve for an air flow from Item 17.
22. Item 21 times Item 15.
23. For an efficient system, 20% of Item 21.
24. Item 23 times Item 15.
25. Item 21 plus Item 23.
26. Item 22 plus Item 24.
27. Item 26 times Item 16.
28. Based on Items 19 and 27.
29. From blower manufacturer's curve for selected blower.
30. With the air duct sealed, operate the blower. Measure the pressure. In this example, the pressure of 5.3" H_2O verifies the system integrity. If the measured value was not close to Item 29 a system check would be needed for: air leaks, blower power, or measurement errors.

31. Remove the air duct exit seal and the tube from its socket. Operate the blower and measure the pressure. In this example, the pressure of 3.2" H_2O is the back pressure generated in the system only. Use this pressure to verify the original estimate of system pressure during typical operation. From this pressure on the blower manufacturer's curve, determine the CFM for the system alone. Verify Item 23 by solving as follows:

$$\begin{aligned} \text{System Pressure} &= \frac{(\text{Item 17})^2}{\text{CFM}^2} \times \text{Item 31} \\ \text{(Typical Operation)} &= \frac{195^2}{620^2} \times 3.2 \\ &= 0.32" \text{ H}_2\text{O} \end{aligned}$$

This value should be equal to or less than Item 23. If it is in excess of Item 23 the system pressure drop is greater than 20% of the tube drop and indicative of a less efficient system.

32. Insert the tube into the socket and without power applied to the tube, operate the blower and measure the pressure. (Measured value in this example of 4.1" H_2O corresponds with the blower manufacturer's curve as shown in Figure 5.)
33. From blower manufacturer's curve determine air flow for pressure of Item 32.
34. Apply FAT to Item 33 to determine Equivalent Flow (User's Lab to Tube Specification).
This example: Altitude = Sea Level, $\Delta T = +30^\circ$.

$$\begin{aligned} \text{Equivalent Flow} &= F_{AT} \times \text{Item 33} \\ &= 1.0 \times 1.1 \times 310 \\ &= 341 \text{ cfm} \end{aligned}$$

35. Using Item 34 on the Cooling Characteristic Curve, determine the Mean Anode Core Temperature for the Heat Dissipation of Item 3.
36. In the same manner as Items 34 and 35, determine the Maximum Mean Anode Core Temperature using the air flow from Item 20.

$$\begin{aligned} \text{Maximum Mean Temperature} &= F_{AT} \times \text{Item 20} \\ &= 1.0 \times 1.1 \times 237 \\ &= 261 \text{ cfm} \end{aligned}$$

From Cooling Characteristic Curve determine Maximum Mean Core Temperature. In this example the value of 178 °C, when compared with Item 35 of 170 °C emphasizes the need for care and accuracy in design and measurement.

37. Operate the transmitter and blower at prescribed conditions for long enough to stabilize the temperature. At the air flow of Item 33, the mean core temperature should be equivalent to Item 35. Using prescribed methods determine the mean core temperature. In this example, the measured values were taken at four points on the anode and were 195, 175, 145 and 165 °C for an average temperature of 170 °C which verified Item 35.

If Item 37 is a satisfactory value when compared with Item 35 and Item 36, the equipment is thermally ready for installation at its final site.

Section VI

Measurements

To evaluate the overall equipment design, the user must know the air flow, the pressure drop, and the seal and core temperatures of the tube.

Temperature

The final measure of cooling performance is the temperature of the tube measured at specified locations on the anode core and seal terminals during operation at environmental conditions.

The temperatures can be determined through the use of special temperature-sensitive paints manufactured by the Tempil Division, Big Three Industries, Inc., Hamilton Boulevard, So. Plainfield, NJ 07080. This "Tempilac" paint is available for specific temperatures in steps of 20° to 30° C. In use the paint is applied sparingly to the tube. If the specified temperature is exceeded, the paint will melt and change appearance from dull to shiny. Usually several dabs of paint, each with a different temperature rating are used simultaneously to obtain accurate maximum temperature readings. Apply the paint in dots with a small wire or paper clip. A one-sixteenth to one-eighth inch dot is sufficient. Space adjacent dabs approximately one-quarter inch apart. Remove all residue from previous measurements to insure against error. The measurements can be accurate to better than $\pm 10^\circ$ which is usually adequate.

In measuring the maximum temperature of BURLE power tubes, care must be taken to note the temperature at several locations and record the maximum value. The variation across the tube can be as much as 50° C.

Pressure

To assure adequate cooling the pressure capability from the blower must exceed the pressure differential across the system for the required air flow. This can be verified by measuring the static pressure at various locations of the system. This pressure is the difference in the height of water in a simple "U" tube nanometer measuring the pressure at several locations. (See Figure 6)

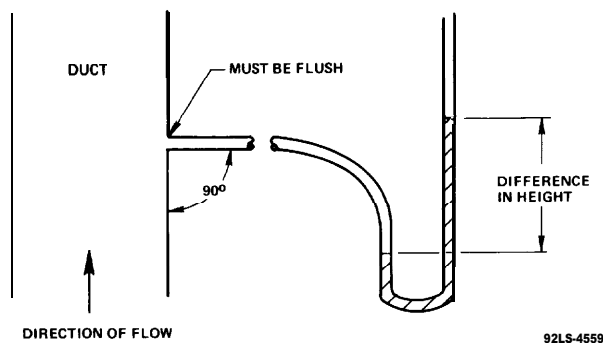

Figure 6 - Static Pressure Measurement

Care must be taken to measure static and not velocity pressure. Static pressure is taken normal to the direction of air flow from a hole flush with the inside of the duct. Avoid creating turbulence or obstructing the flow. If air is blowing at the hole, velocity pressure will be measured and the reading will be in error on the high side. Do not measure near bends in the ducts. Take measurements well down stream from discontinuities.

Air Flow

The final measurement is volumetric air flow. To make this measurement the equipment designer must use a special meter designed specifically for the purpose. These meters are made by numerous manufacturers and vary from hot-wire types for low-flow levels to velocity-pressure-reading velometer types for high flows.

It is important that velocity pressure measurements be made into the direction of flow as shown in Figure 7. Avoid creating turbulence or obstructing the flow. Take measurements well down stream from discontinuities.

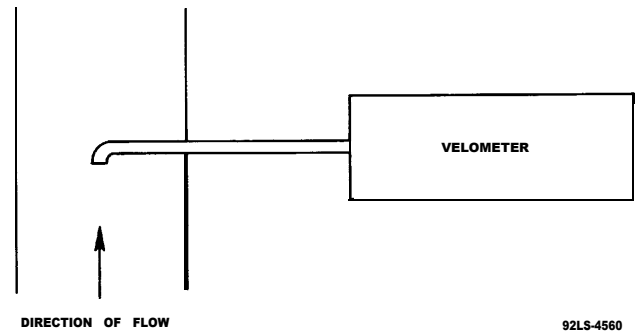

Figure 7 - Air Flow Measurement

It is recommended that several velocity readings be taken in the air flow duct. The duct should be divided into three or more zones and velocity readings taken in each of these zones. For example, for a duct of six inches in diameter divide it into three zones as shown in Figure 8.

The area of the zones is not critical, and should be made as convenient as possible. The location of the velocity readings are shown by the x's in each zone. A convenient method is to take the readings at the center of zone 3 extending the velometer 1/2" inside the duct, then move it to the center of zone 2 and 3" to the center of zone 1. Determine the velocity in each zone by averaging the velocity readings in that zone. Multiply the area of each zone by the averaged velocity readings taken in that zone. The volume flow in each zone is the averaged velocity (ft/min) times area (ft²) which equals ft³/min (CFM). Add the CFM for each zone to obtain total CFM. Because of the wide variation in the readings, averaging all the velocity readings and multiplying

by the total duct area will yield an incorrect result. Never make the velocity readings immediately above the tube. The discontinuities and turbulence will cause errors as high as two to one. In ducts with laminar flow and long straight runs the approximate CFM is 0.8 x velocity in the center of the duct in feet per minute x the area of the duct in square feet.

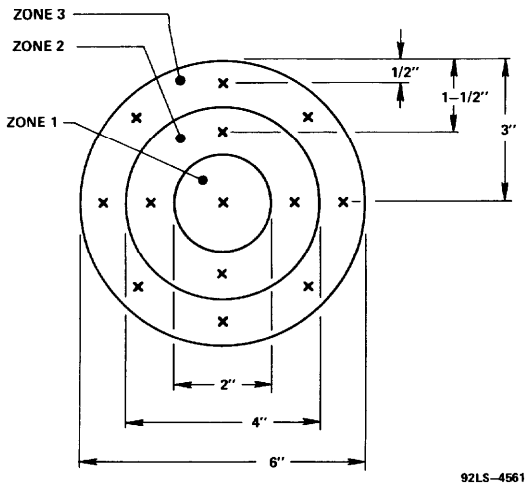

Figure 8 - Zone Division of Cooling Duct for Air Flow Measurement

Section VII

General Considerations

As shown in **Figure 4b** the Rotron AS-704 blower is capable of supplying 237 CFM at a static pressure drop in excess of 4.0 inches H₂O when operating at a line frequency of 60 Hz. It is very important to note that this same blower when operated at a line frequency of 50 Hz (operation in some other countries) is capable of supplying 237 CFM at a static pressure drop of 2.8 inches H₂O which is inadequate for the application cited in the example. The importance of the blower operating line frequency cannot be overemphasized.

If the blower characteristics are not shown for 50 Hz operation, the 50 Hz operation can be simulated by reducing the blower rpm to 5/6 of the 60 Hz operation. As shown above, the Rotron AS-704 blower operating at 50 Hz would not meet the cooling requirements of the application cited in the example. A larger blower, capable of supplying 237 CFM at a static pressure drop in excess of 3.2 inches H₂O when operating at 50 Hz, would be required. Another solution would be to operate two Rotron AS-704 blowers in series. The total back pressure in the air path is then divided between the two blowers. It is recommended that

this practice be limited to two blowers and that guidance be asked of the blower manufacturer. The net pressure obtainable is usually 1.9 x pressure of one blower. Blowers can also be operated in parallel to obtain additional CFM at unity pressure gain.

To insure proper cooling of the tube, the anode core and terminal seal temperatures should be checked under actual operating conditions by the method outlined in Section VI. The anode core and terminal seal temperatures should be cooler than the design goal for operation at environmental conditions.

In many instances it is impossible to measure air flow and pressure drop at the environmental conditions, however, temperature tests on the anode core and terminal seals should be made at the environmental conditions to guarantee proper cooling of the tube.

The overall system can be further checked by measuring inlet and outlet air temperature and using the general heat transfer equation which applies at any condition of temperature and altitude:

$$Q = MC\Delta T$$

where Q = heat

M = air mass

C = specific heat of air

ΔT = air temperature change

For sea level calculations this equation reduces to:

$$\text{CFM} = 1760 \text{ kW} / \Delta T_c$$

where kW is the power in kilowatts being dissipated and ΔT_c is the difference in temperature between the input and output cooling air to and from the tube.

The resultant CFM must exceed the CFM required to cool the tube as specified.

Section VIII

Summary

In summary, it is first necessary to ascertain how much heat is to be dissipated. The next step is to determine the flow of air needed to dissipate this heat. Convert the tube specification conditions to those of the operating environment. Further apply the environment conditions to the requirements of the blower. It is then necessary to evaluate the completely constructed system before turning on the power amplifier, and verify the operating performance in the user's laboratory before putting it into practice in the ultimate operating environment.

Finally, the entire system should be checked after final installation.

This paper has been primarily concerned with the effects of conditions on the anode cooling air. If separate sources are used to cool other electrodes, similar considerations should be given to these flows and pressures.

For quick selection of blower, the following procedure may be used:

Step 1 - Select the volume flow (CFM) and pressure drop (P) for prescribed tube operation at tube specification conditions. Multiply the P for the tube by 120% to allow for system loss.

$$\begin{aligned} \text{Volumetric Flow} &= \text{CFM}_1 \text{ ———} \\ \text{Pressure Drop for the tube} &= P_{t1} \text{ ———} \\ \text{Pressure for the system} &= P_{t1} \text{ ———} \times 1.20 \\ &= P_{s1} \text{ ———} \end{aligned}$$

Step 2 - Apply correction factors for temperature (F_T) and altitude (F_A) to the Volumetric Flow (CFM) and System Pressure (PS) from Step 1.

$$\text{where } F_T = \frac{273 + T_2}{273 + T_1}$$

T₁ = Tube Specification Temperature
T₂ = Operating Environment Temperature
and F_A is selected for operating altitude.

$$\text{CFM}_2 = \text{CFM}_1 \times F_T \times F_A$$

$$P_{s2} = P_{s1} \times F_T \times F_A$$

Step 3 - Apply correction factors for temperature (F_T) and altitude (F_A) to the pressure (P_s) to compensate for blower specifications.

$$\text{where } F_T = \frac{273 + T_2}{273 + T_3}$$

T₂ = Operating Environment Temperature
T₃ = Fan Specification Temperature
and F_A is selected for operating altitude.

$$P_{s3} = P_{s2} \times F_T \times F_A$$

Step 4 - Obtain a blower capable of delivering in excess of CFM₂ at a pressure of more than PS₃ for rated line frequency and power.

From the example shown in the paper, the computations and determinations for each step are as follows:

Table II Reference

CFM ₁ = 195 cfm	17
P _{t1} = 1.60 in H ₂ O	21
P _{s1} = 1.60 x 1.20	
= 1.92 in H ₂ O	25

CFM ₂ = 195 x 0.97 x 1.25	
= 237 cfm	18

P _{s2} = 1.92 x 0.97 x 1.25	
= 2.33 in H ₂ O	26

P _{s3} = 2.33 x 1.07 x 1.25	
= 3.14 in H ₂ O	27

Rotron AS-704	28
---------------	----

All specifications subject to change without notice. Information furnished by BURLE INDUSTRIES, INC. is believed to be accurate and reliable. However, no responsibility or liability is assumed by BURLE for its use, nor for any infringement of patents or other rights of third parties which may result from its use. No license is granted by implication or otherwise under any patent or other rights of BURLE INDUSTRIES, INC.

Copyright 1989 by BURLE TECHNOLOGIES, INC. All Rights Reserved.
BURLE® and BURLE INDUSTRIES, INC.® are registered trademarks of BURLE TECHNOLOGIES, INC. Marca(s) Registrada(s).